



Corp.

Excellence in Communications

Product Overview

June 2002

EiC Corp.

Excellence in Communications

Contents

- Company background & Contact Info
 - Slides 3-5
- Technology
 - Slides 6-13
- Broadband Gain Block Amplifiers
 - Slides 14-28
- Power Amplifier Modules
 - Slides 29-50

EiC Corp.

A Silicon Valley Integrated Design Manufacturer (IDM) focused on RFICs.



Pioneered the development of InGaP GaAs HBT's for power amplifiers.

In-house 4" GaAs HBT wafer fab

Strong international management and technical team.

EiC Corp.

Excellence in Communications

Our Market Focus

- Broadband Infrastructure Applications
 - Wireless Communications
 - Optical Fiber Communications
 - Cable TV
- Cellular Handset Applications
 - CDMA → CDMA 1X → cdma2000 / WCDMA
 - GSM → GPRS → WCDMA

Contact EIC Corporation

- EIC Corp Headquarters

- Fremont, CA. Main no. (510) 979 8999
Sales no. (510) 979 8953; fax (510) 979 8902
- www.eiccorp.com sales@eiccorp.com
- To locate our **Representatives**...refer to EIC Web Site

- Distributed in Asia and America's by

- (866) AVNET RF www.avnetrf.com



- Distributed in Europe by

- (44) 1908 326 326
- www.bfioptilas.avnet.com
- RFsales.UK@bfioptilas.avnet.com



EiC Corp.

Excellence in Communications

InGaP HBT Technology

EiC Corp.

Excellence in Communications

Enabling Technologies for RFICs

Performance	GaAs HBT	GaAs PHEMT	Si Bipolar	RF CMOS	SiGe HBT
High breakdown voltage for RF power Circuits	High	High	Low	Low	Low
RF Power Efficiency	High	High	Low	Very Low	Low
Single Supply	Yes	No	Yes	Yes	Yes
Linearity	High	High	Medium	Low	Medium
RF Front-end Chip Set	Fair	Fair	Good	Very Good	Very Good
Cost	Medium	High	Low	Low	Medium

•InGaP/GaAs HBT: Best technology for high performance and highest reliability, medium to higher power amplifiers !!

InGaP VERSUS AlGaAs HBTs

AlGaAs HBT

- **Mature Technology in Production for a Number of Years**
- **Widely Accepted in the Field**
- **More Epi-wafer Suppliers**
- **More Reliability Data; less reliable**

InGaP HBT (EiC Leadership)

- **Proven Technology in Production**
- **Better Reliability**
- **Higher Current Handling**
- **Smaller Die Size**
- **Better Temperature Stability**
- **Lower Turn-on Voltage**
- **Constant Current Gain over Decades of Collector Current**
- **Better Manufacturability**
- **Lower Phase Noise in Oscillators**

EiC Corp.

Excellence in Communications

HBT Epi Structures

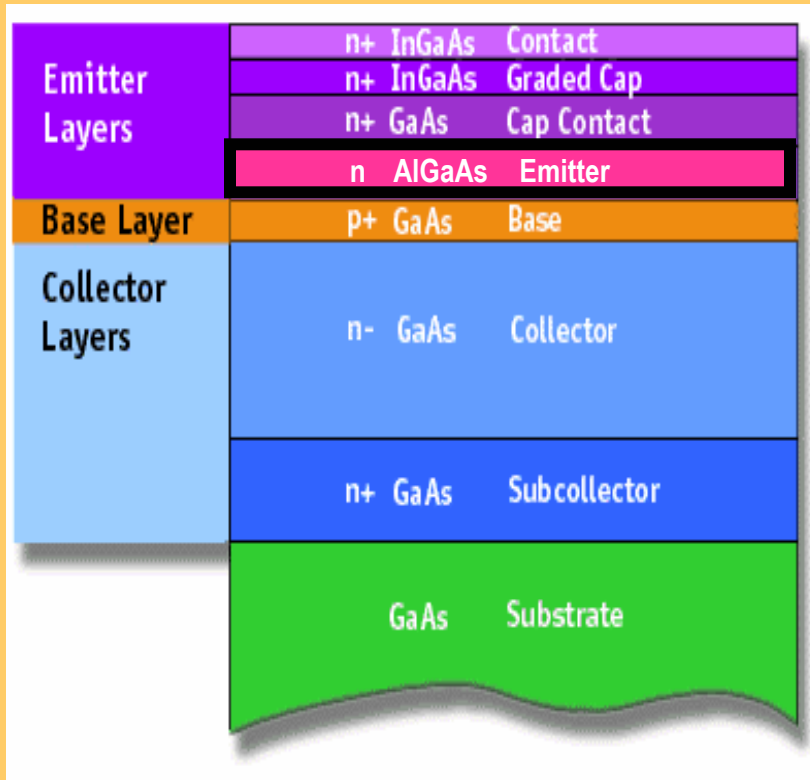

AlGaAs/GaAs HBT

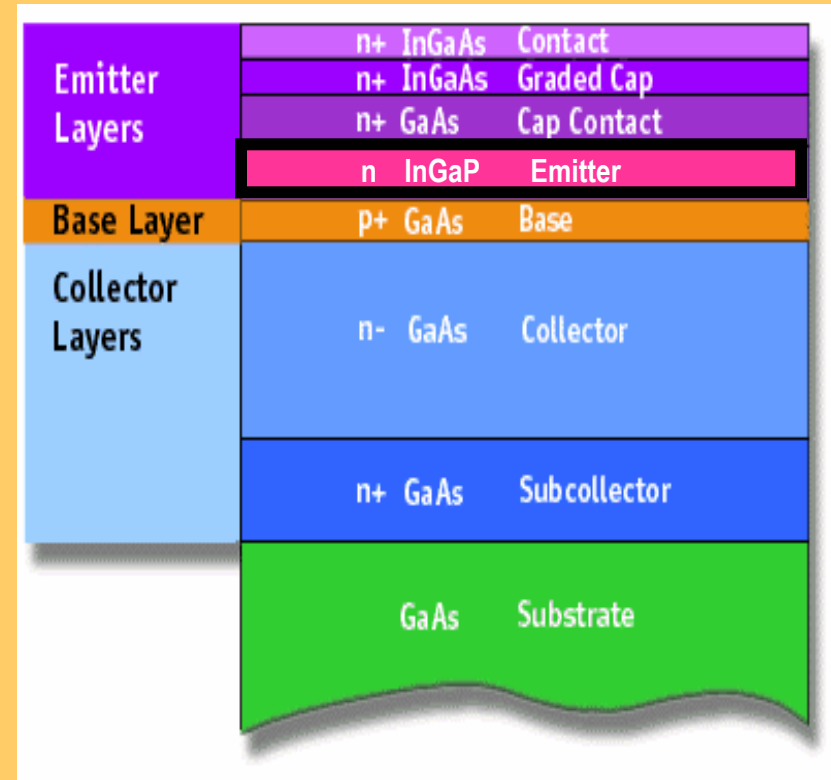

InGaP/GaAs HBT

InGaP/GaAs Advantages

- InGaP emitter forms better E/B junction
 - Better lattice structure; less defects than AlGaAs
 - Higher current handling
- MOCVD for epitaxial growth
 - Molecular Organic Chemical Vapor Deposition
 - Low temperature process allows for Carbon doped base for stability over temperature and current
- All this adds up to the most RELIABLE and LOWEST COST solution

•InGaP HBT Reliability

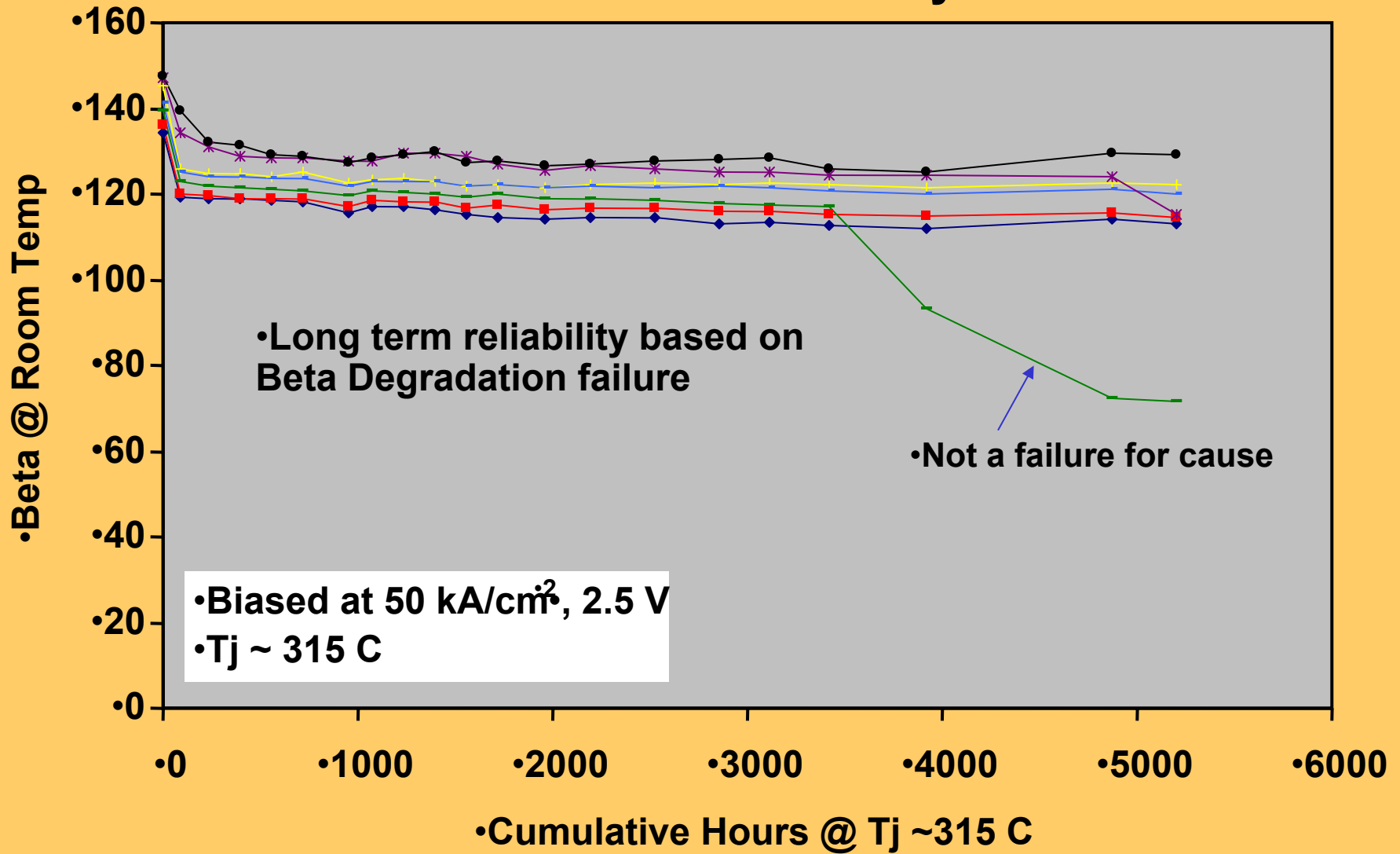

EiC Corp.

Excellence in Communications

InGaP HBT Reliability

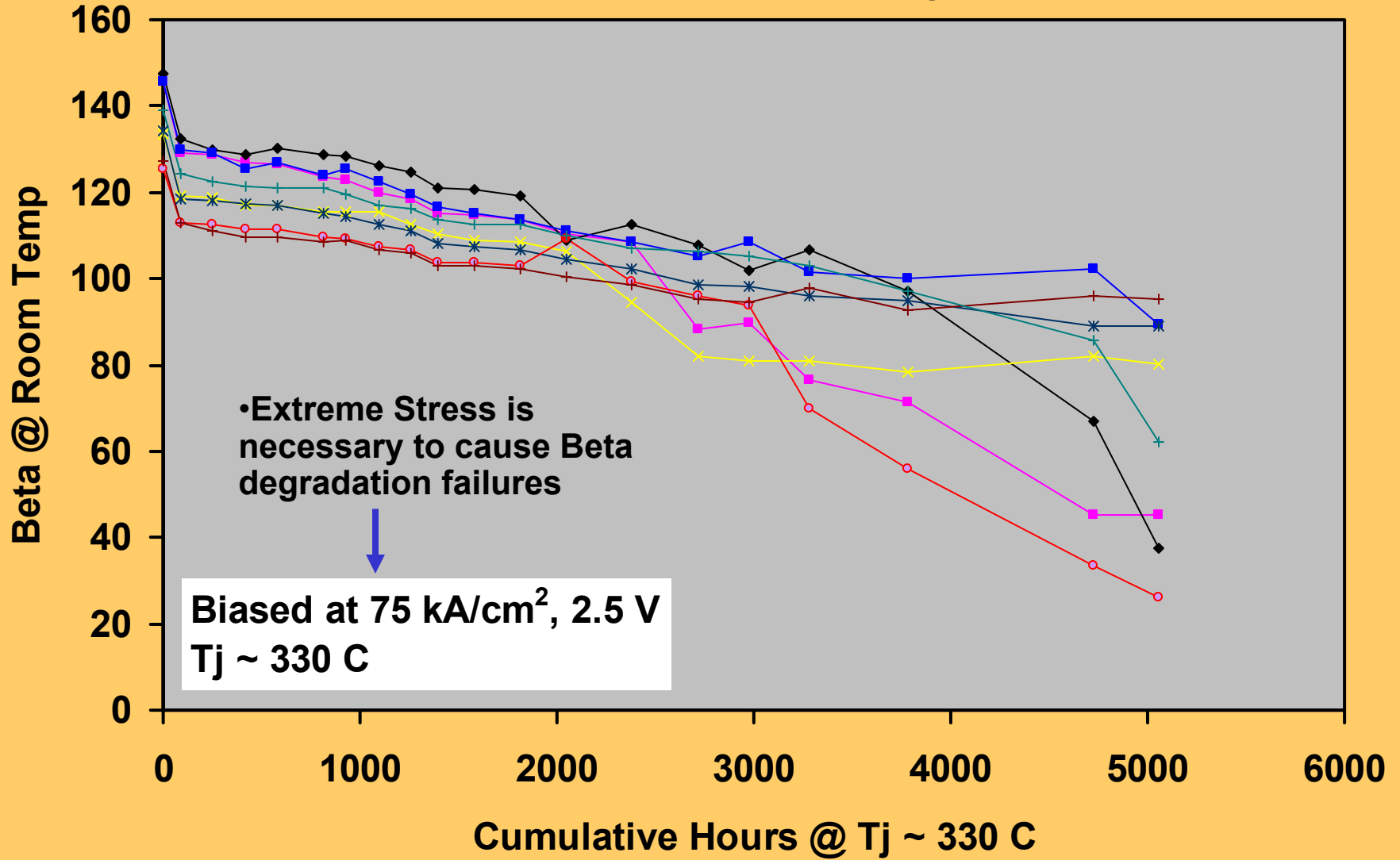

EiC Corp.

Excellence in Communications

RELIABILITY ADVANTAGE (MTTF)

1/KT (1/eV)

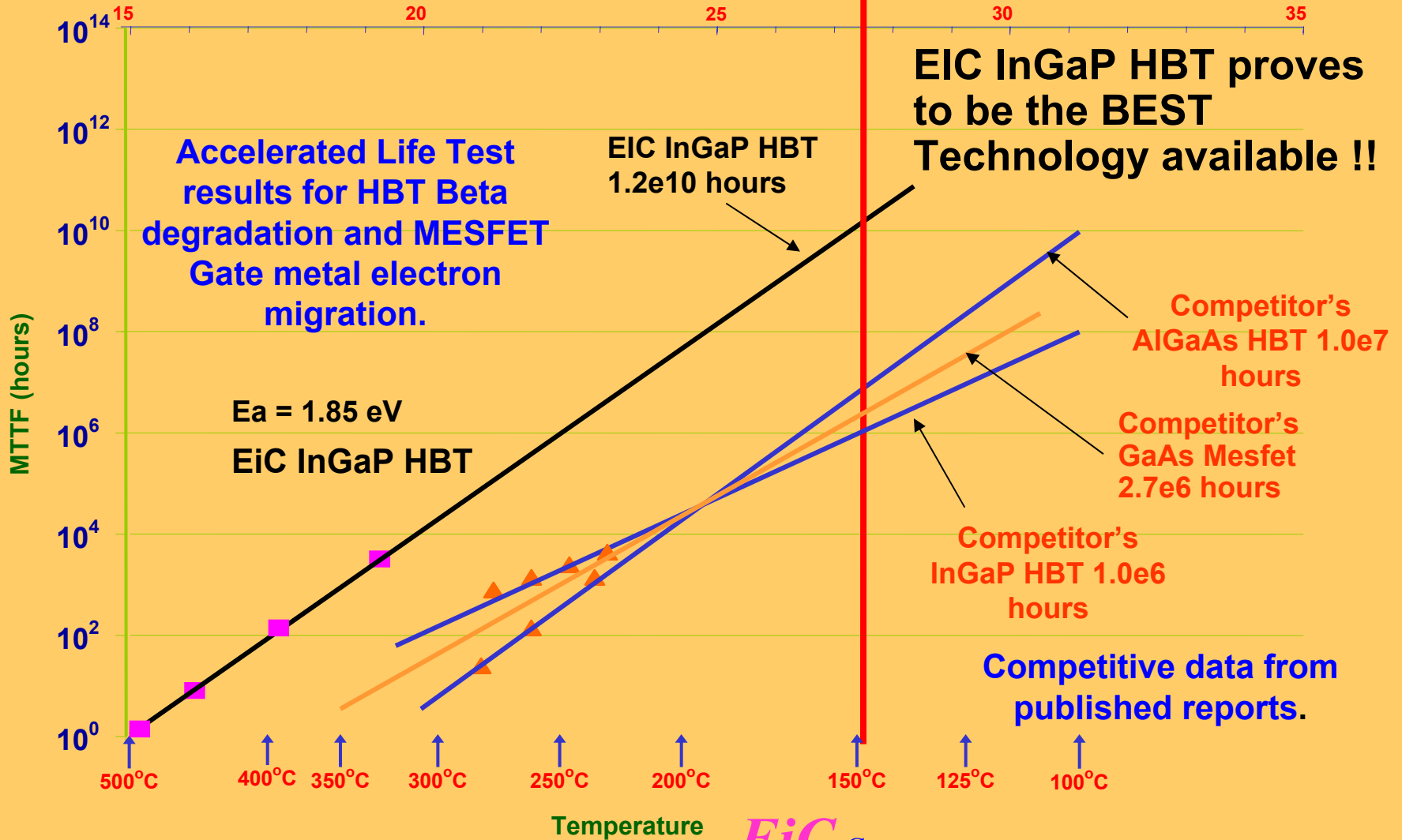

EiC Corp.

Excellence in Communications

Broadband Amplifiers for Infrastructures

EiC Corp.

Excellence in Communications

Leadership Products

- EiC supplies gain block, broad band amplifier IC's, to major base station infrastructure manufacturers
- Cellular base station applications demand superior reliability and performance
- Infrastructure Broadband Amplifiers based on EiC's proprietary InGaP/GaAs HBT technology provide:
 - **The Best Linearity** (critical for 3G)
 - **The Best Reliability** (>1000X better than competition)
- EiC's Broadband Amplifiers being shipped to Primary base station suppliers today

EiC Corp.

Excellence in Communications

EiC Gain Block Product Evolution

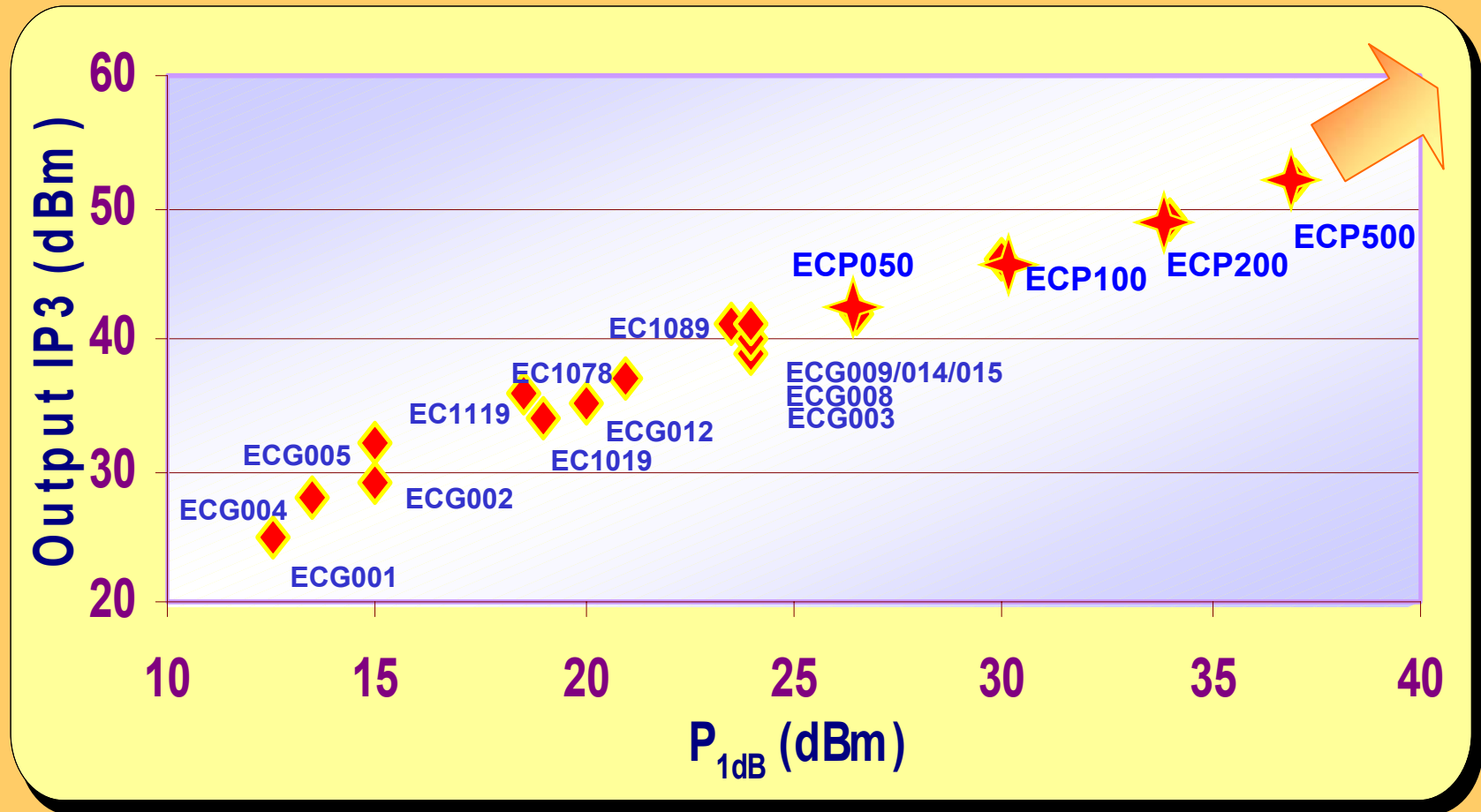

◆ = Released ★ = Under Development

EiC Corp.

Excellence in Communications

EiC's Gain Block Selection

Broadband Linear Amplifier	Small Signal Gain (dB)	Noise Figure (dB)	Output P1dB (dBm)	Output IP3 (dBm)	Input Return Loss (dB)	Output Return Loss (dB)	ΔT_j	BW {MHz}	Vde (V)	Icc (mA)	Package
ECG014	20.5	5.0	24.0	42	15	10	45°C	50-2000	5.0	100	B
ECG015*	15.0	5.0	24.0	41	15	10	45°C	1800-2500	5.0	100	B
ECG009	19.0	5.1	24.0	41	15	10	65°C	DC-3000	5.0	150	B
ECG003	20.0	3.5	24.0	39	12	12	45°C	DC-6000	7.2	110	B
EC-1089	15.0	5.1	23.5	42	15	10	65°C	DC-2500	5.0	150	B
ECG008	15.0	5.0	23.0	40	15	10	75°C	DC-6000	7.3	120	B
EC-1078	19.5	4.4	21.0	37	12	8	65°C	DC-6000	6.0	96	B,C
ECG012	14.0	5.1	20.0	36	15	10	65°C	DC-2500	3.0	100	B
EC-1019	18.5	5.0	19.0	34	19	15	45°C	DC-6000	5.0	70	B,C
EC-1119	14.8	5.5	18.6	36	20	24	60°C	DC-6000	4.8	80	B,C
ECG005*	18.5	4.3	18.5	33	16	15	40°C	DC-6000	4.8	65	B,C
ECG002	20.0	4.0	15.0	29	15	15	23°C	DC-6000	3.9	45	B,C,F
ECG006	15.0	4.0	15.0	32	15	15	23°C	DC-6000	3.9	45	B,C,F
ECG001	20.0	3.8	12.0	26	15	15	17°C	DC-6000	3.4	30	B,C,F
ECG004*	15.0	3.0	12.0	26	15	15	17°C	DC-6000	3.4	35	B,C,F

*Data taken at 2 GHz All other data at 1 GHz

PACKAGE CODES: B: SOT89 C: Micro X
F: SOT363 G: SOIC8 H: LCC

Note:	High Linearity	Darlington
-------	----------------	------------

EiC Corp.

Excellence in Communications

EiC Darlington Amplifier Features

- 50 ohm input/output internal matched MMIC
- Easy to use functional blocks
- Available in several small surface mount plastic packages
 - SOT363, SOT89, micro-X
- Very broad band application
 - DC to 6GHz

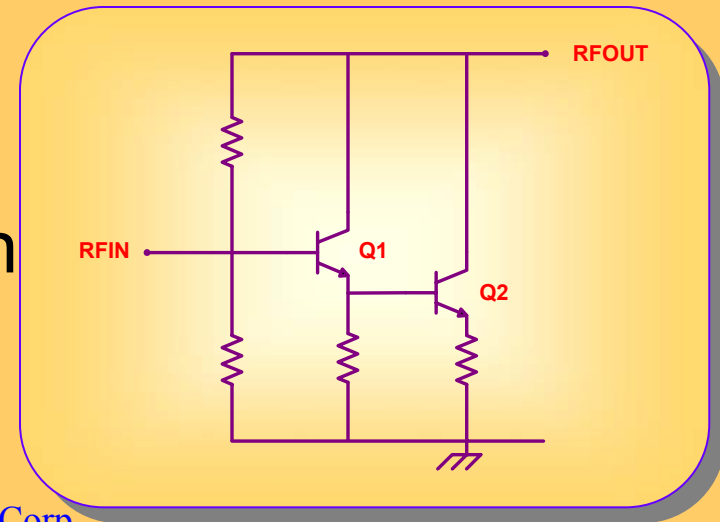

Gain Stability - Darlington

Gain vs. Frequency ECG006

(IC Tested on Eval Board)

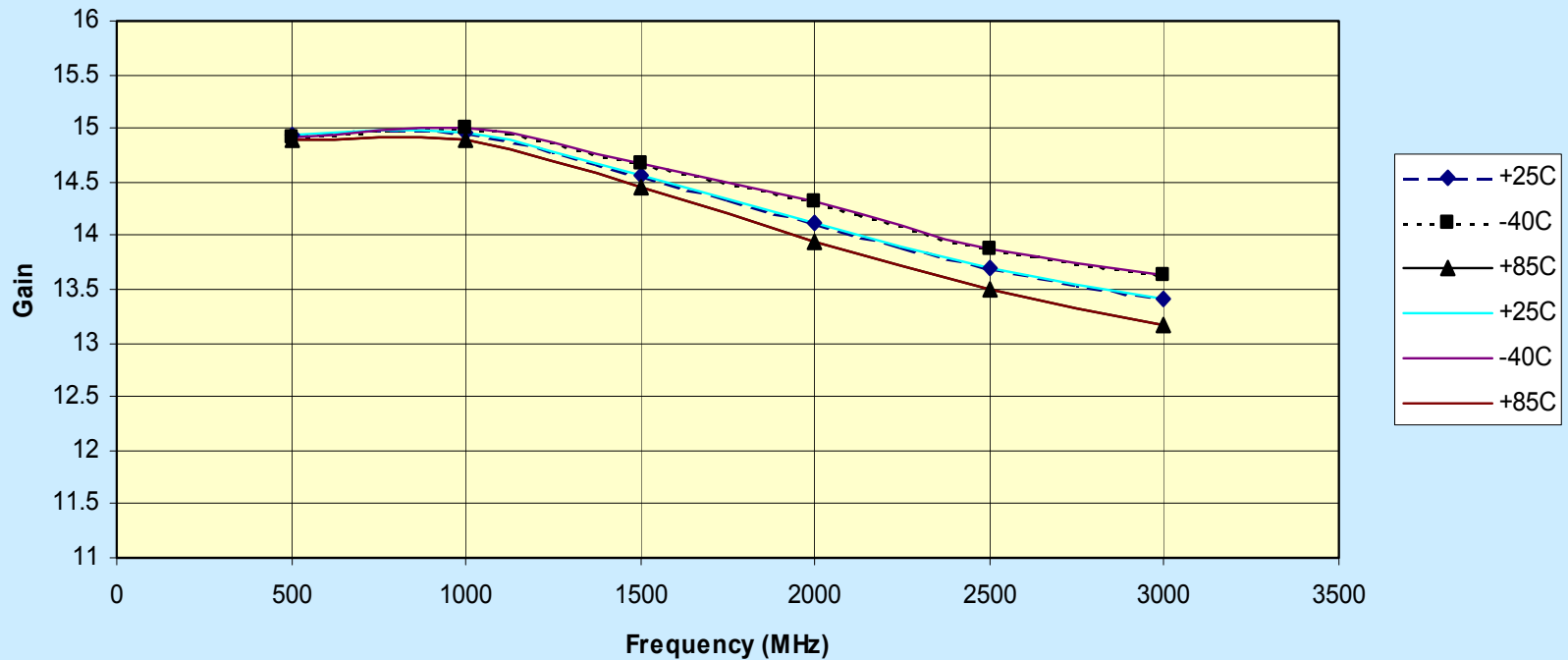

EiC Corp.

Excellence in Communications

EiC High Linearity Amplifiers Features

- Require external matching circuit to each frequency bands of interest
- High linearity with OIP3 >40dBm (min.)
- Typical $S_{11} < -15\text{dB}$ with external PCB matching circuit
- Low thermal resistance
- SOT89 package

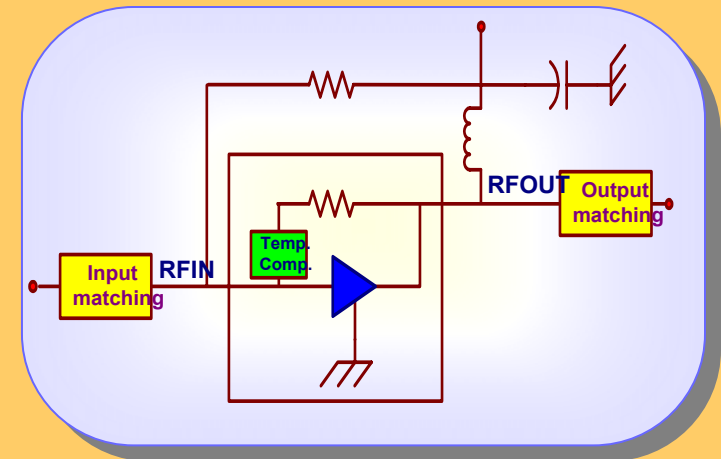

EC1089 / ECG009

■ Common Features

- Can directly connect to 5V supply
- $I_{cc}=150\text{mA}$ (typical)
- P1dB~24dBm
- Optimized performance with external matching circuits for each band
- On chip temperature compensated bias circuit

■ Product Differentiation

- Gain @900MHz
 - EC1089:15dB
 - ECG009:19dB
- Gain @1.9GHz
 - EC1089: 13dB
 - ECG009: 14dB
- Gain @2.14GHz
 - EC1089: 12dB
 - ECG009: 13.5dB

ECG014 / ECG015

■ Common Features

- Allow $V_{cc} > 8V$ operation with a bias resistor
- Low current, $I_{cc} \sim 100mA$ (typical)
- $P1dB \sim 24dBm$
- Optimize performance with external matching circuits for each band
- Stable gain over all operating temperature range

■ Product Differentiation

- Different frequency band of application
 - ECG014: 50MHz - 1.9GHz
 - ECG015: 1.8GHz - 2.5GHz
- Gain
 - ECG014:
20dB @900MHz
15dB @1900MHz
 - ECG015
15.5dB @1900MHz
15dB @2140MHz
14dB @2450MHz

EVG014 Gain vs. Temperature

3 Eval boards at 1.9GHz

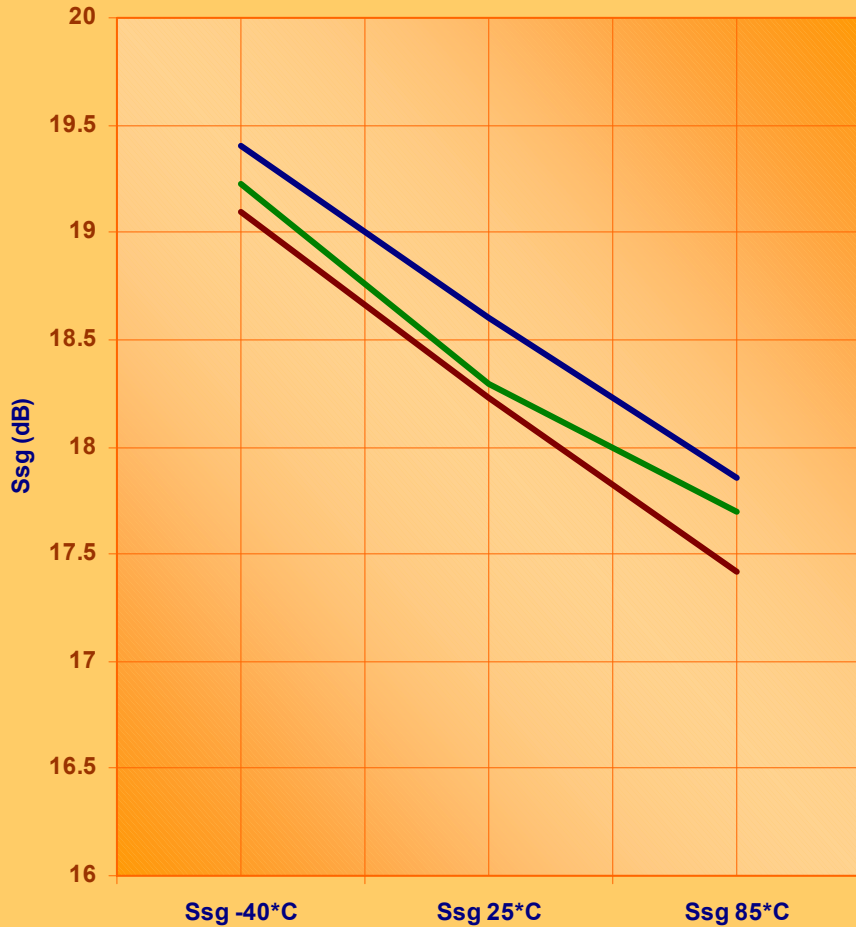

3 Eval boards at 900MHz

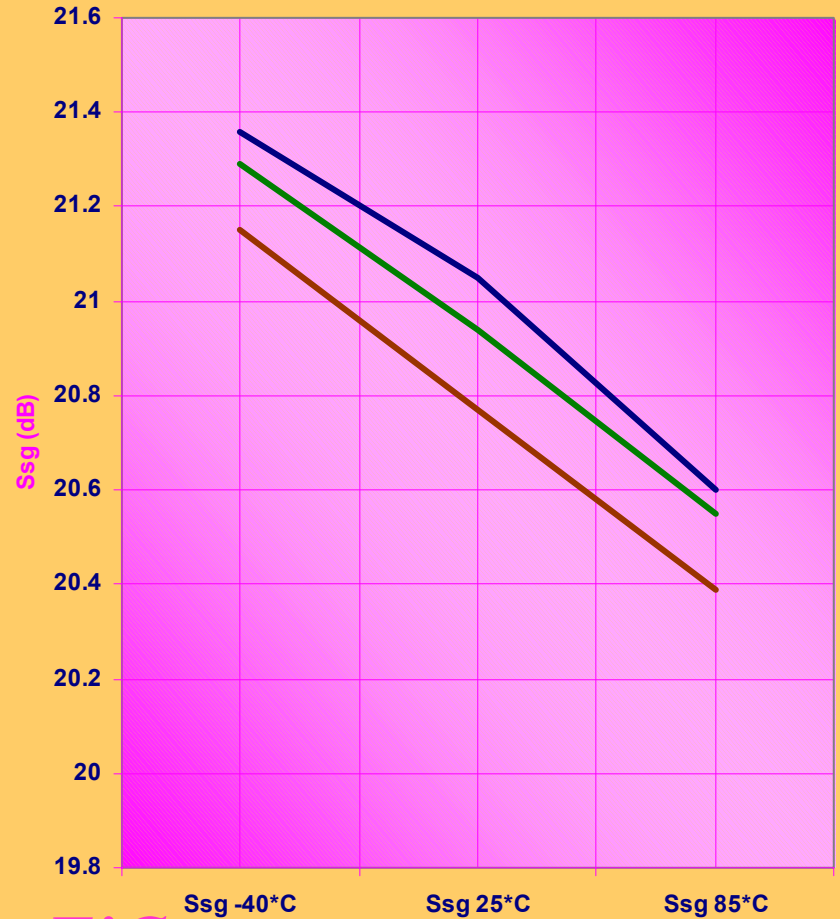

EiC Corp.

Excellence in Communications

EC1019 Gain SPC Distribution

EC1019 Gain @ 3GHz

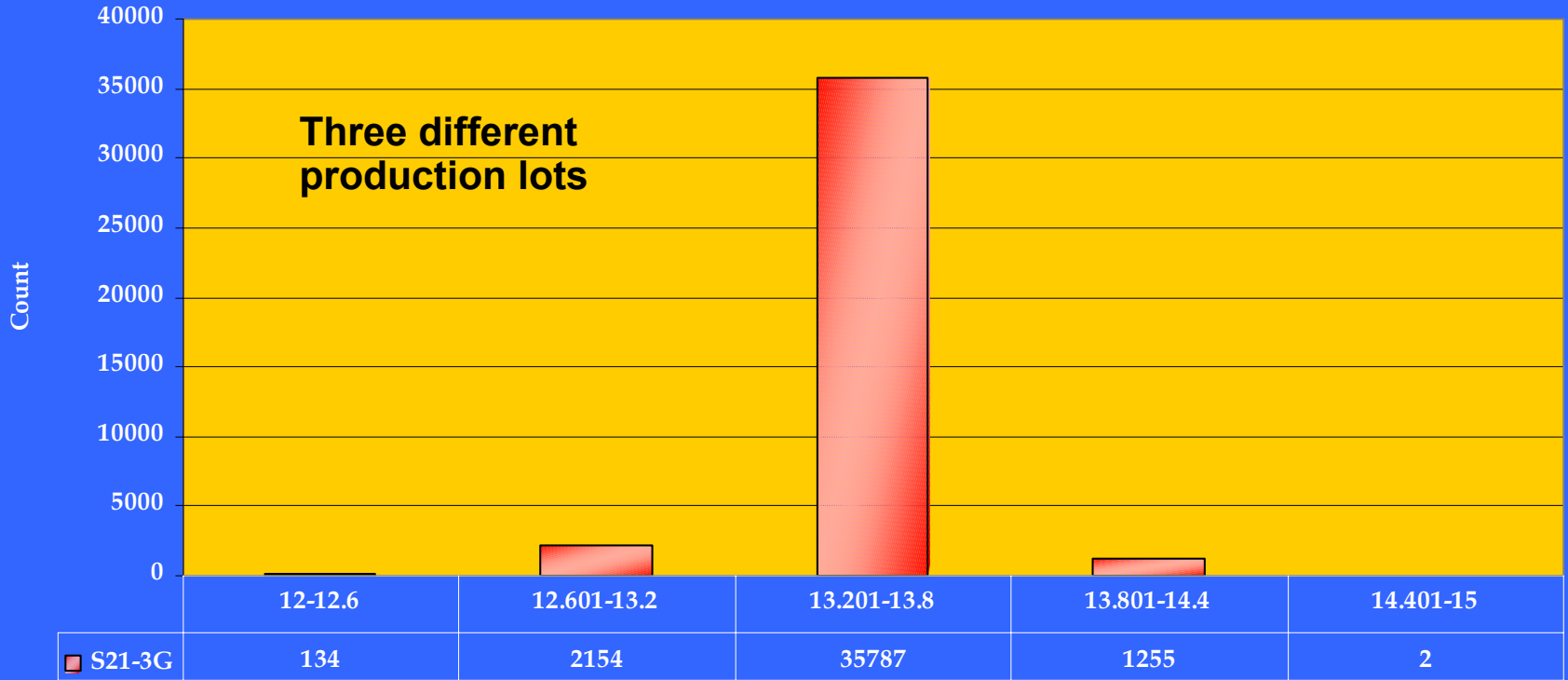

Benefits of EiC's Gain Block Amplifiers

- Leading-edge performance (Linearity, Temperature Stability, Robustness)
- A complete product family
- Consistent and tight performance distribution
- Consistent quality and delivery from in-house fab
- Good part traceability
 - Wafer fab process lot and package lot numbers are coded on all package marking
 - In-house wafer PCM / final testing SPC data are available for failure analysis
- High reliability EiC InGaP HBT technology
- Low junction temperature through thermal design

EiC Corp.

Excellence in Communications

IPA
Intermediate Power Amplifier
Coming Soon

EiC Corp.

Excellence in Communications

IPA's Key Features

- Temperature compensated bias circuit is included
- Class A / Class AB bias can be selected
- Surface mount package
- High P1dB at -45dBc ACPR...linear operation
- EiC InGaP HBT reliability

Intermediate Power Amplifier

Target Performance

- One Stage amplifiers
- Adjustable Current feature
- SOIC-8 or 4x4 mm LCC package

	0.5 watt	1-watt	1-watt
	1800-2300 MHz	800-1000 MHz	1800-2300 MHz
	ECP050	ECP102	ECP100
P-1(dBm)	27	30	30
Gain(dB)	13	15	12
Pout(ACPR=-45dBC)	18.0	22.5	21.0
Gain Flatness/200MHz	±0.2dB	±0.2dB	±0.2dB
Phase Flatness/200MHz	±0.7°	±1.2°	±1.2°
S11 (dB)	-15	-15	-15
Vcc (V)	5	5	5
Iop(mA)	250	400	400
OIP3(dBm)	42	45	45
NF(dB)	6.5	7.5	7.0

EiC Corp.

Excellence in Communications

Power Modules for 2G & 2.5G Cellular Handset

EiC Corp.

Excellence in Communications

PAM Product Families

	Cellular			PCS		DCS	WCDMA	Size
	US	Japan	GSM	US	Korea			
CDMA	ECM001	ECM005		ECM004	ECM008/ ECM028*			6 X 6mm
CDMA w/ Step Bias Control	ECM011			ECM014	ECM018		ECM010	6 X 6mm
	ECM051*			ECM054*			ECM050*	4 X 4mm*
IS136 TDMA	ECM806			ECM807				
GSM / GPRS-12			ECM007	ECM007		ECM007		9 X 11mm
			ECM009	ECM009		ECM009		6 X 6mm

* Sample in Q2 2002

EiC Corp.

Excellence in Communications

EiC PAM Product Evolution

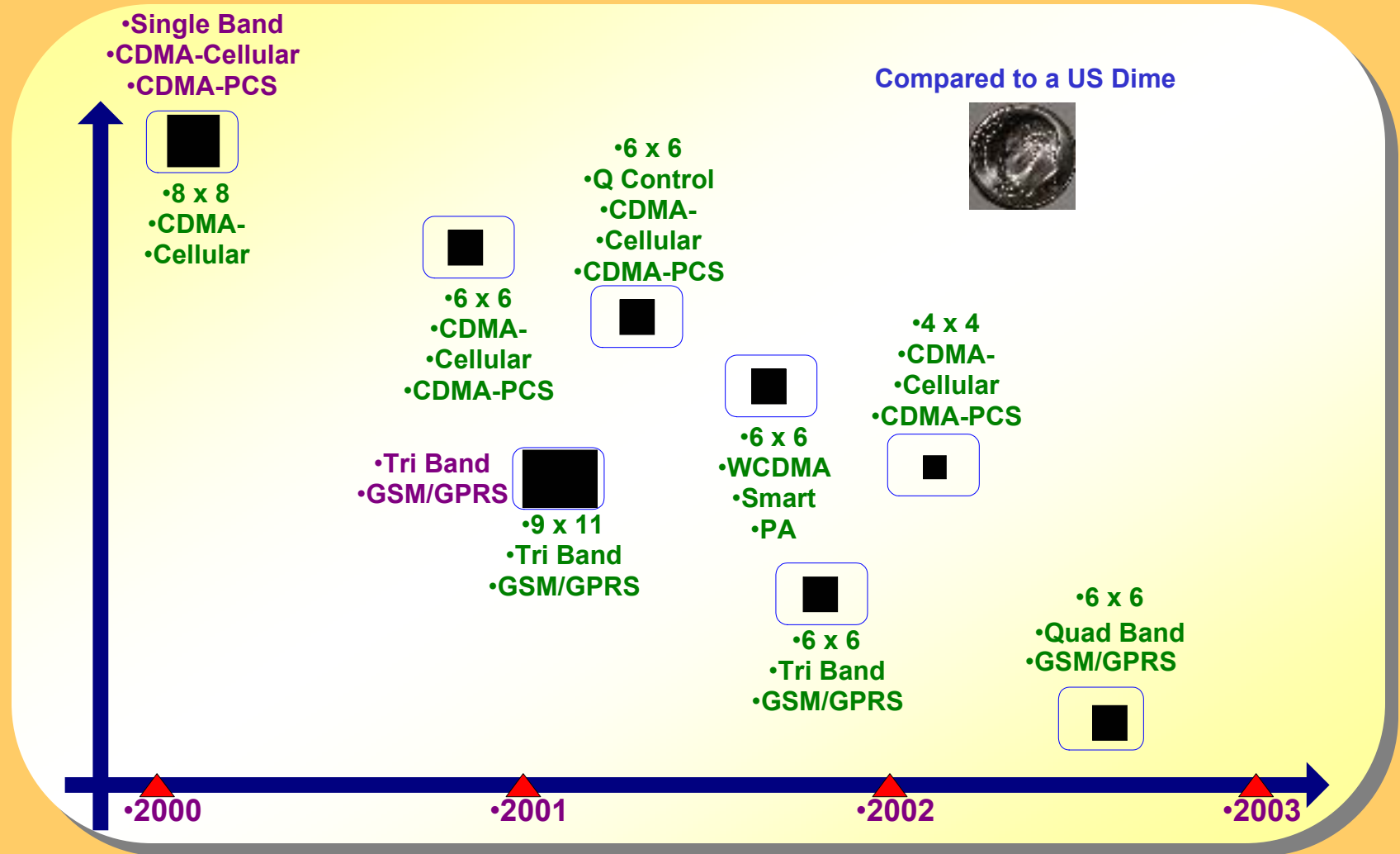

EiC Corp.

Excellence in Communications

New GSM Leadership Products

- New GPRS Handset Power Amplifiers
 - Unique single-chip tri-band design allowing smallest form factor package.
 - Superior thermal design allowing Class 12 GPRS data rates.
 - Available in 6X6 and 9X11 mm LCC packages
- New GPRS Class 12 products position EiC to serve **2.5G handset and PDA** (Personal Digital Assistant) customers as well as existing GSM cellular phones
- **Leading technology to serve a growing market**

EiC Corp.

Excellence in Communications

Benefit of GPRS-12 Tri-band PAM

- World's 1st InGaP HBT GPRS Class 12 Tri-Band PAM
- High Module Assembly Reliability with **Single HBT Die**
- ECM009 is the industry's **smallest footprint** (6x6mm) Tri-Band GSM solution
- ECM007 is compatible with CX77302 and RF3160 with the benefit of class 12 operation

Key Features of GSM / GPRS Tri-band PAMs

- 9x11mm and 6x6mm footprints (2 PAMs)
- 50 ohms matched at Input and Output
- Tri-band Operation (GSM / DCS / PCS)
- GPRS class 12 operation (50% duty cycle)
- Compatible with ADI, LT & Phillips Power Control IC
- APC has over-voltage protection
- Low ΔP_{out} / ΔV_{apc} for easy control

World's Smallest GSM/GPRS Power Amplifier Module

TX Section

- GSM/GPRS Class 12
- Single chip tri-band power amplifier module
- Manufactured using EiC's industry leading InGaP HBT process

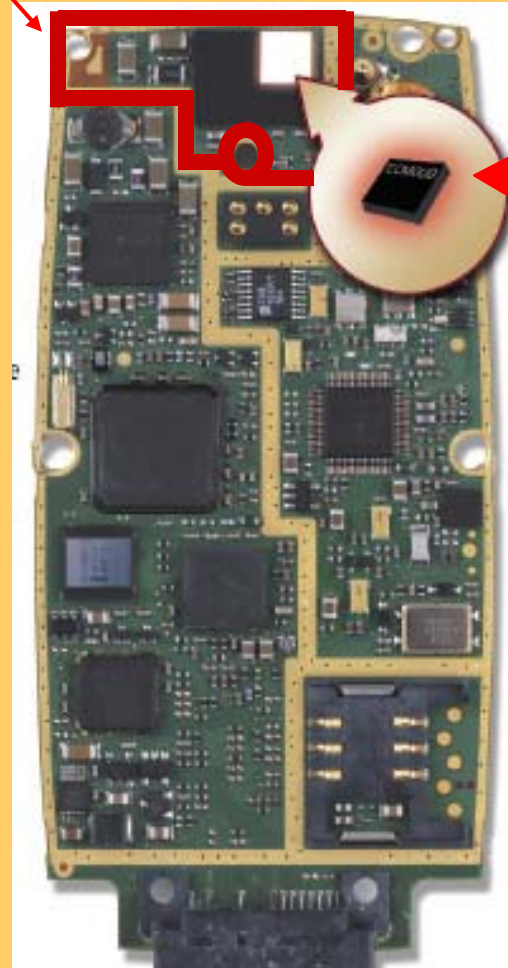

ECM009

- 1/3 the size of current product available
- Increases design flexibility for smaller handsets and PDAs
- Provides more space for increased functionality

EiC Corp.

Excellence in Communications

GSM band Power Control Frequency Response

Vset vs Pout & Icc at Room Temp.

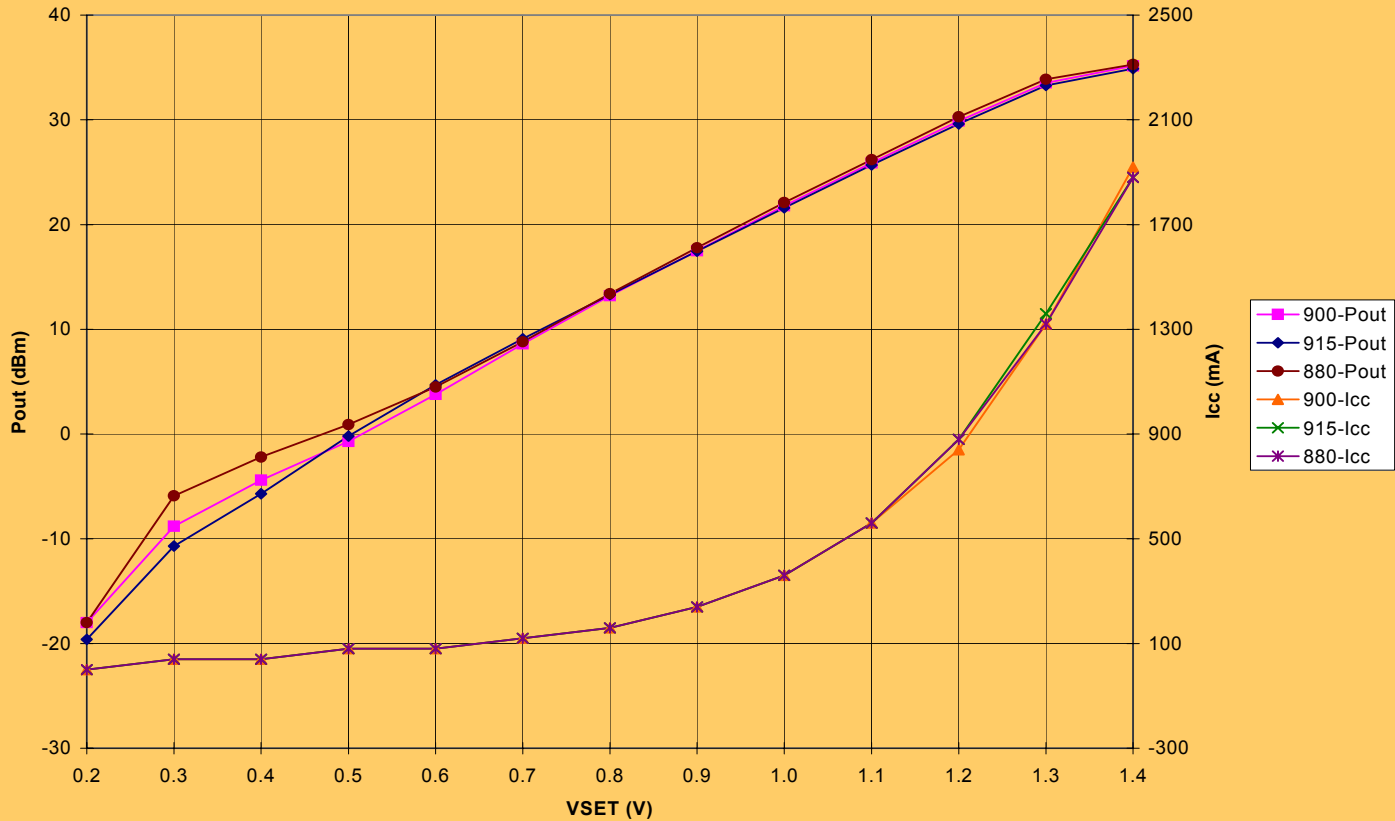

EiC Corp.

Excellence in Communications

GSM Band Power Control Temperature Response

Pout, Icc vs VSET@900MHz

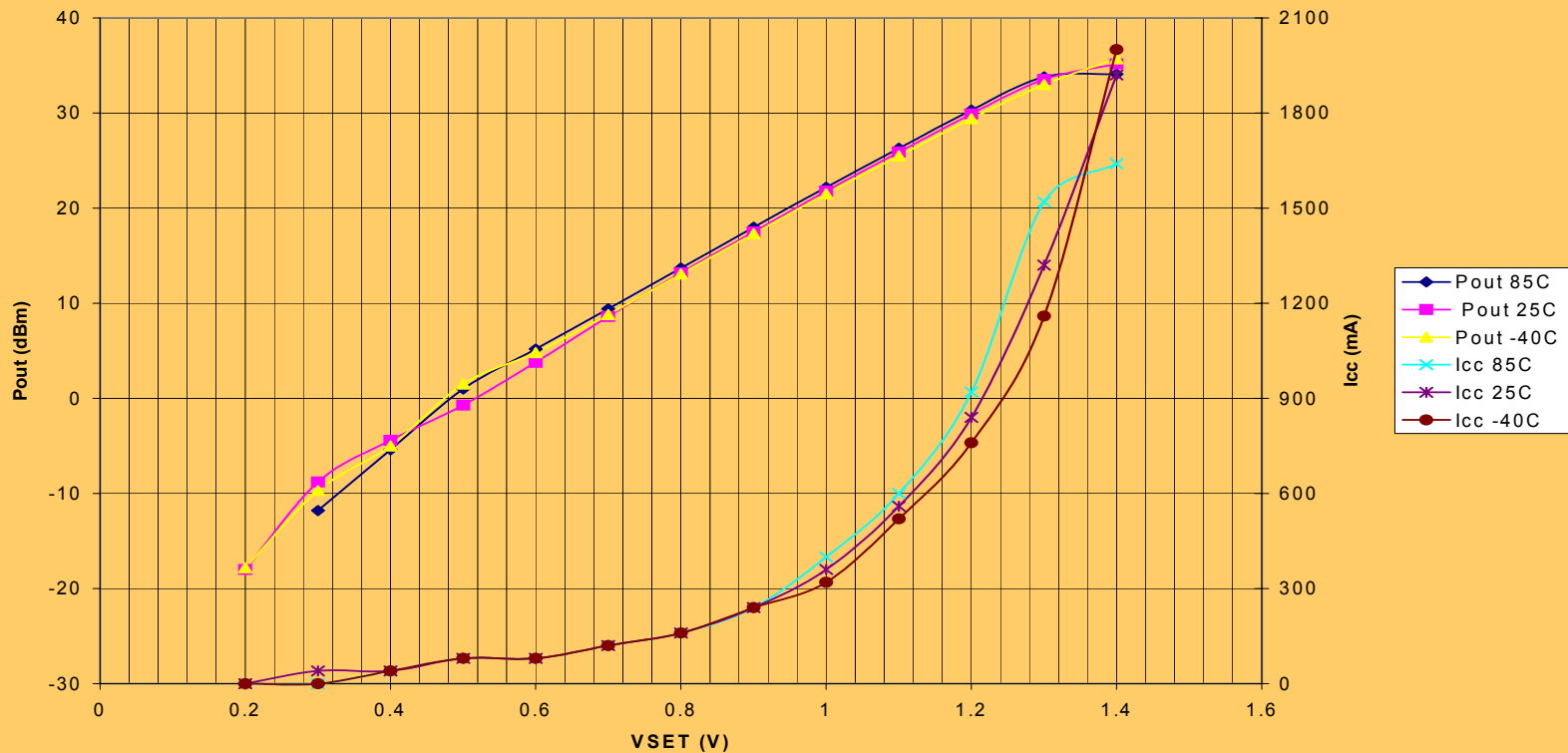

EiC Corp.

Excellence in Communications

DCS Band Power Control Temperature Response

Pout, Icc vs VSET@1.75GHz

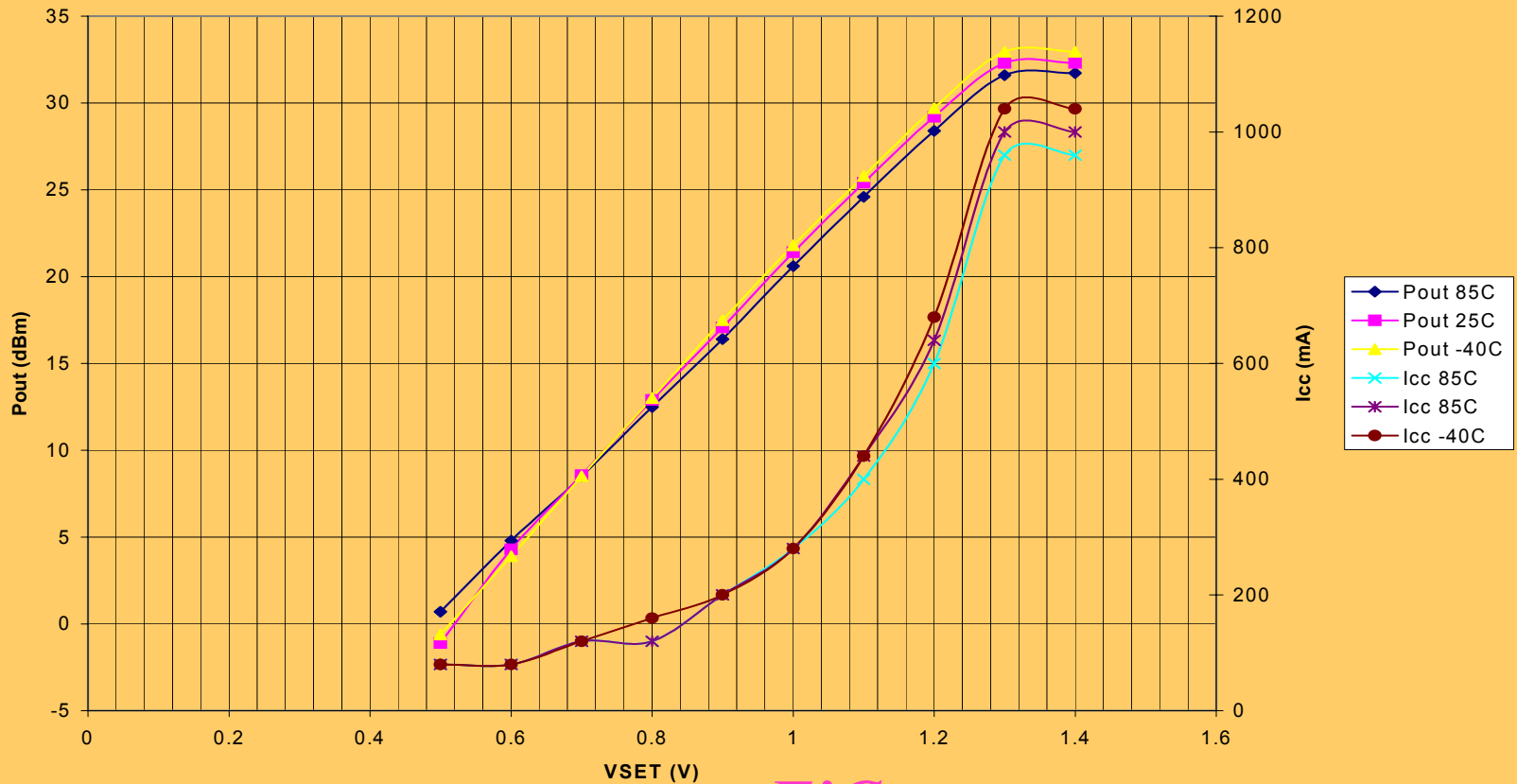

EiC Corp.

Excellence in Communications

Leakage Current

	25°C		-40°C		85°C	
Leakage Current	DCS	GSM	DCS	GSM	DCS	GSM
BS	2V	0	2V	0	2V	0
V_{APC}	0	0	0	0	0	0
V_{CC}	3.69V	3.82V	3.69V	3.82V	3.69V	3.82V
I_{CC}	2.8uA	2.9uA	0.9uA	0.9uA	10.8uA	11uA

Conclusion

- ECM007/9 are supported by EiC's highly reliable InGaP HBT process
- Single die for easy module assembly and reliability
- Significant board space savings
- EiC ECM009: 6x6 mm...GPRS-12...Tri-Band means market leadership !!

CDMA Power Amplifier Modules

- EiC CDMA PCS modules have industry leading performance
- New Q-Control (stepped bias) CDMA modules are currently being shipped
- Q-Control modules have superior performance vs. competing solutions and unique features
 - Highest efficiency at lower power mode, 9% @ 16dBm Po
 - Temperature compensation circuitry integrated into chip

Advantages of EiC's CDMA Q-Control PAM Family (1)

- Highest efficiency at lower power mode, 9% @ 16dBm Pout
 - Longer talk time due to higher probability of use at lower power level
 - 9% efficiency at 16dBm is 33% better than “typical” value of leading competitors

Advantages of EiC's CDMA Q-Control PAM Family (2)

- Less temperature sensitivity with on chip temperature compensation circuitry
 - Quiescent current is well controlled over temperature resulting in higher operation efficiency.
 - ACPR is stable over temperature.
 - As phone board heats up, the I_{cq} is kept constant to further conserve battery power.

ECM018 (PCS-K Band) Operation Current vs Probability Density

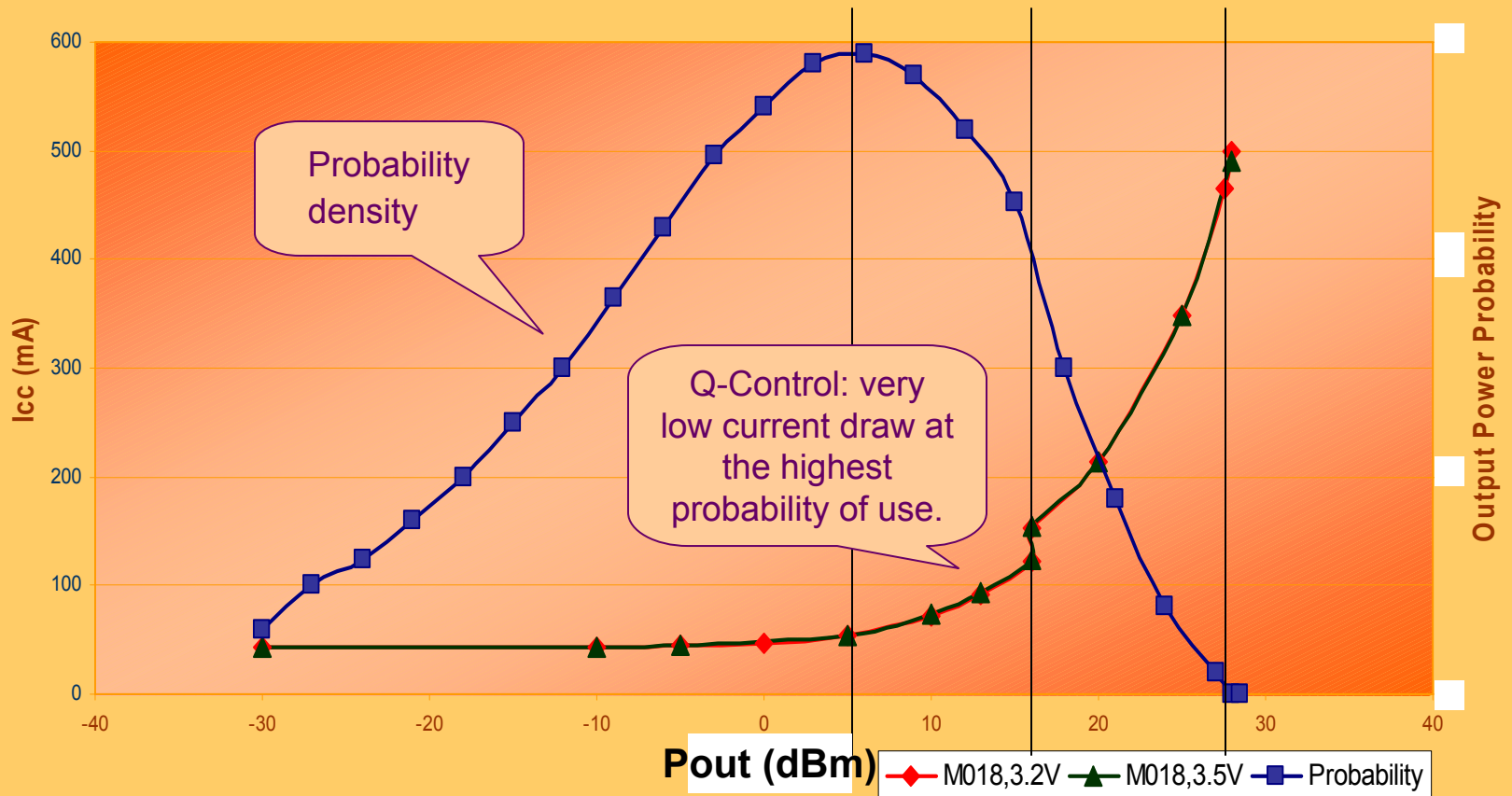

EiC Corp.

Excellence in Communications

Efficiency vs. Pout of WCDMA

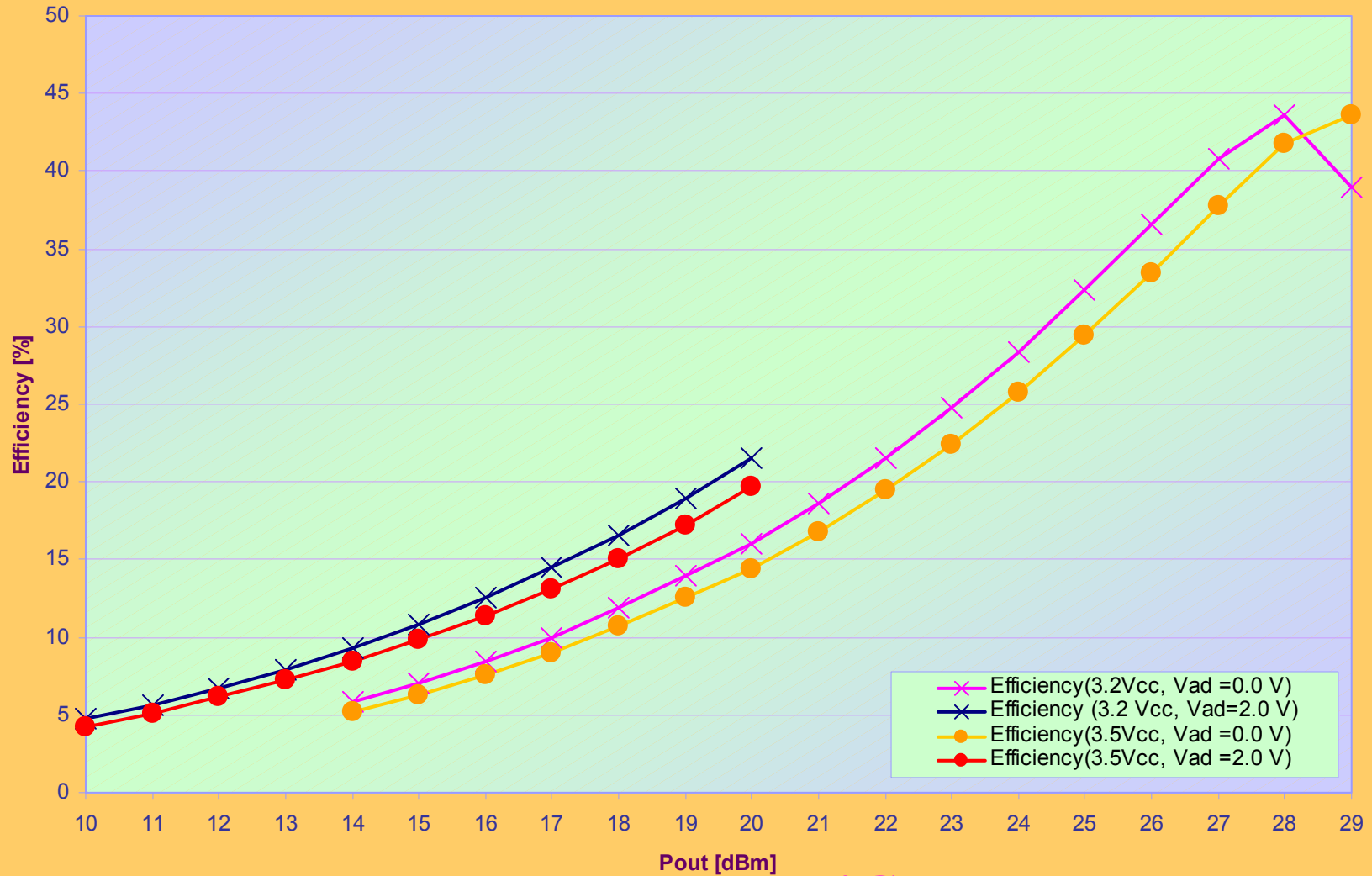

EiC Corp.

Excellence in Communications

Linearity in CDMA System

- CDMA-one (IS-95), CDMA-2000, and WCDMA all operate with time-varying amplitude modulation
- Therefore the amplifier non-linearity will increase the spill over of signal power into adjacent and alternate channels
- The linearity of the PAM is measured by ACPR / ACLR

Spectrum Re-growth through a Nonlinear Amplifier

Spectrum Regrowth due to nonlinear amplification

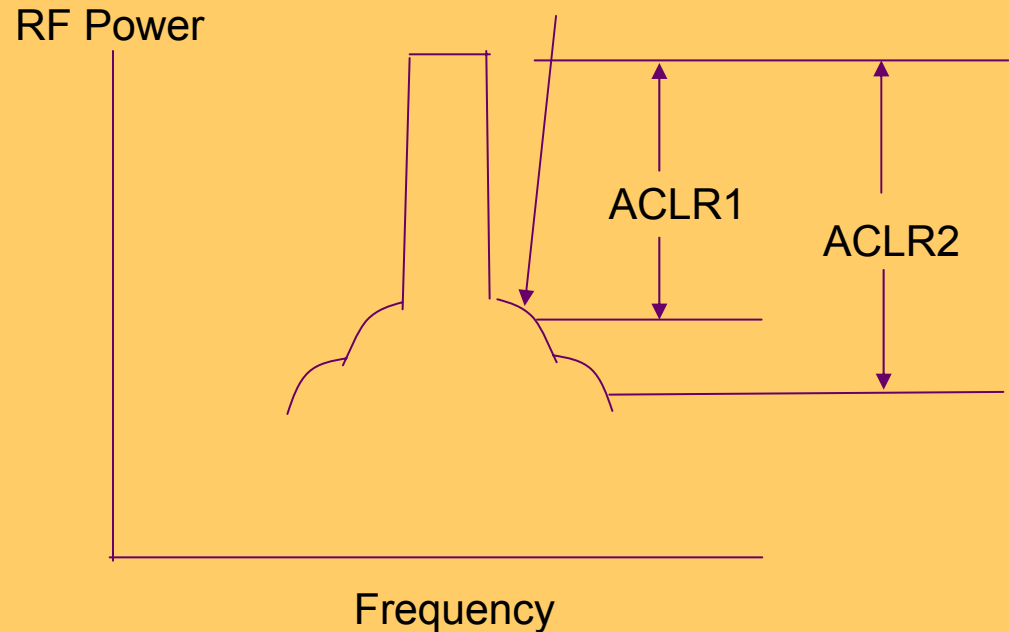
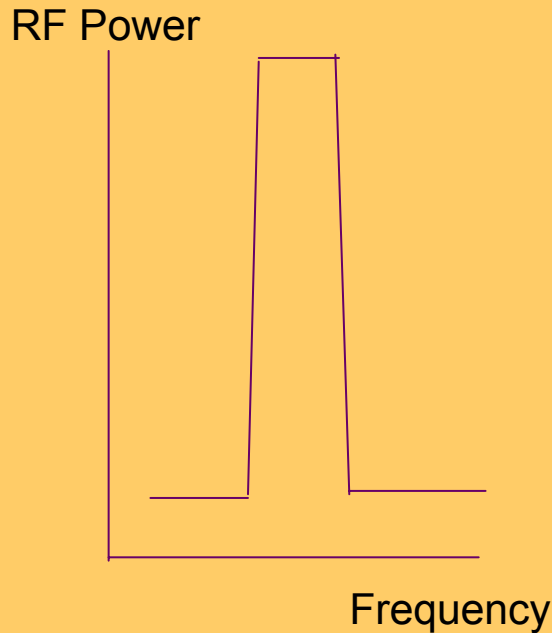

ACLR 1 for WCDMA

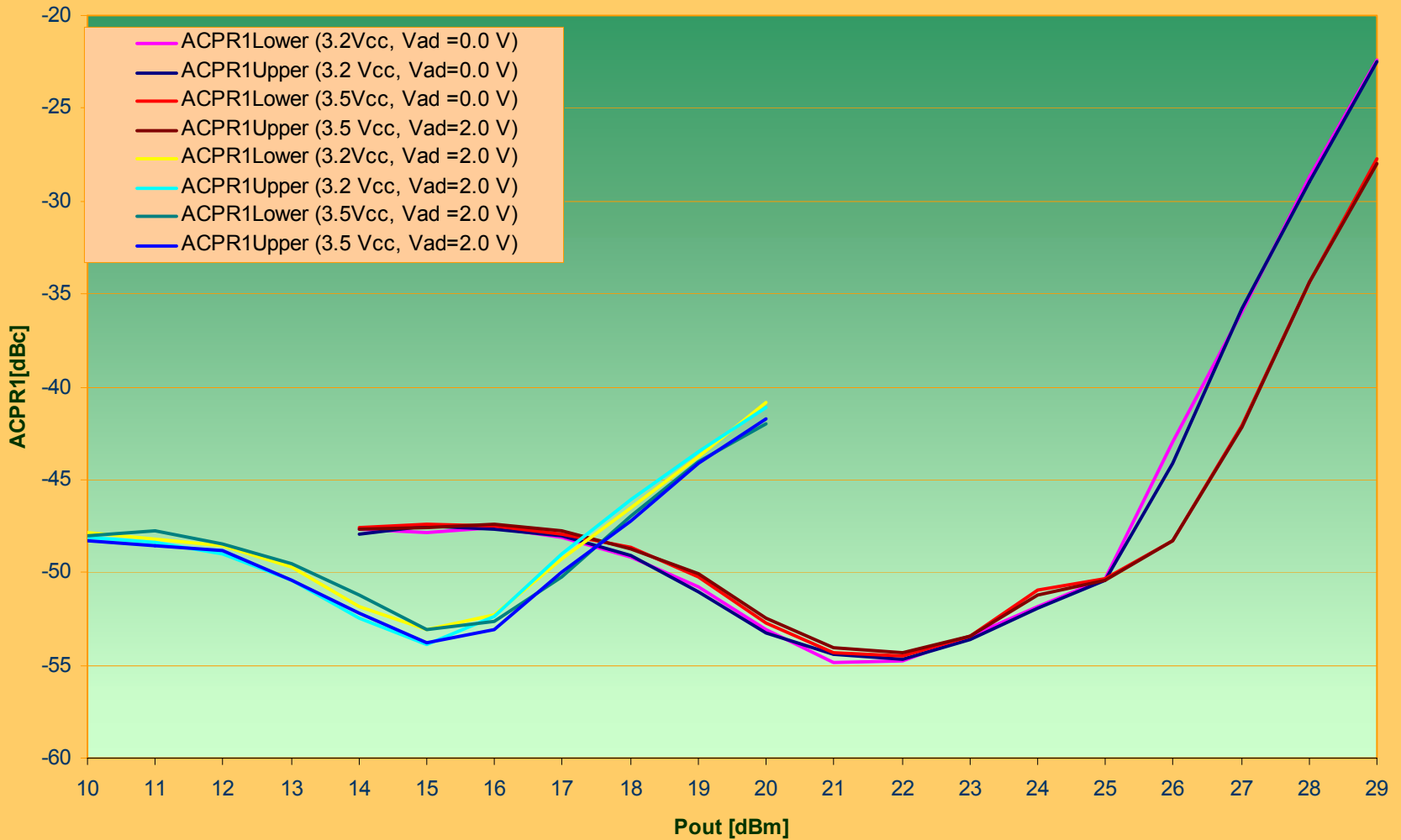

EiC Corp.

Excellence in Communications

ACLR 2 for WCDMA

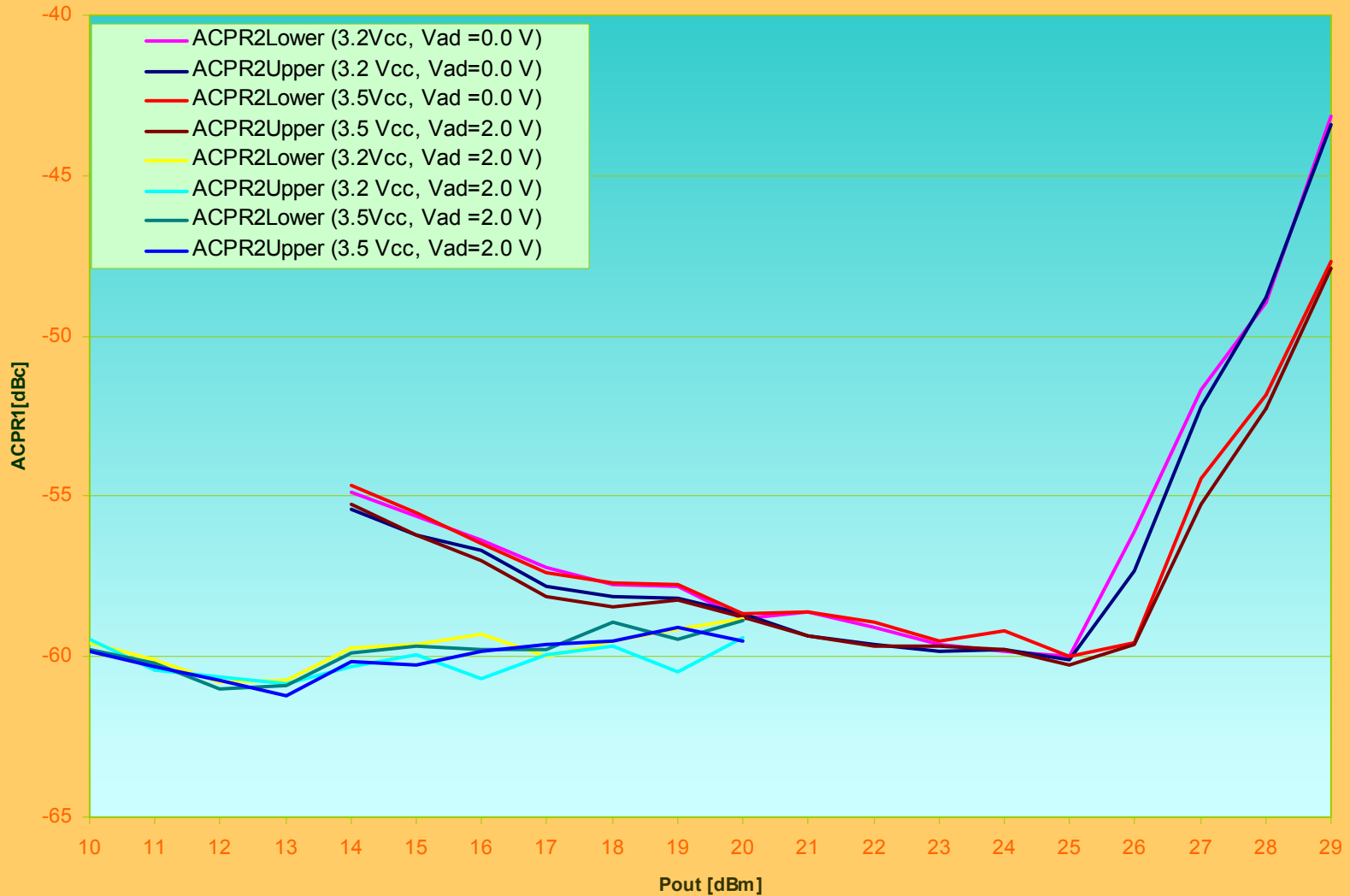

EiC Corp.

Excellence in Communications

Benefits of EiC CDMA Q-Control PAM

- Increased Efficiency at Low Output Power Level
 - Longer Talk Time
 - Q-Control “stepped bias” feature.
 - Quiescent current is well controlled over temperature resulting in higher operation efficiency.
 - Integrated temperature compensation circuit maintains I_{cq} relatively constant.
 - ACPR is stable over temperature.
 - As phone board heats up, the I_{cq} is kept constant to further conserve battery power.
- Same PAM operation current over full temperature range.
- Reliable world class package